













# SCHRADE WALDEN Cutlery

Hand made in the U.S.A. by skilled American craftsmen.

## THE WORLD'S FINEST KNIVES

When you buy a SCHRADE-WALDEN knife, you buy a practical knife made for a specific purpose and to be used for a lifetime. Over half a century of experience combined with incomparable hand craftsmanship give you a product that insures your choice for dependability—every time!

SCHRADE-WALDEN CUTLERY CORP. DIV. OF IMPERIAL KNIFE ASSOC. COS., INC.

136 4 $\frac{1}{8}$ " (HW) \$3.65 	293Y 3 $\frac{7}{8}$ " \$4.65 	805 2 $\frac{3}{4}$ " (WW) \$5.35 	880 4" \$5.35 	<b>HORTICULTURAL KNIVES</b>	
163 4 $\frac{1}{8}$ " (HW) \$3.65 	294 3 $\frac{7}{8}$ " \$4.65 	808 2 $\frac{3}{4}$ " \$4.65 	881 4" \$5.35 	173 6 $\frac{1}{8}$ " (WW) \$1.60 	174 6" (WW) \$1.60 
204SHA 3 $\frac{3}{4}$ " (HW) \$4.35 	708 2 $\frac{3}{4}$ " \$3.65 	808Y 2 $\frac{3}{4}$ " \$4.65 	881Y 4" \$5.35 	175 3 $\frac{3}{8}$ " (BL) \$2.65 	
218 2 $\frac{3}{4}$ " (MP) \$3.65 	708Y 2 $\frac{3}{4}$ " \$3.65 	825 3 $\frac{1}{8}$ " \$5.95 	882Y 4" \$5.35 	176 3 $\frac{3}{8}$ " (IP) \$2.65 	
2 $\frac{3}{4}$ " \$3.65 	735 4 $\frac{1}{8}$ " \$6.65 	832 3 $\frac{5}{8}$ " (WW) \$4.95 	883 4" \$5.35 	182 4" (BL) \$2.95 	
225 5 $\frac{1}{4}$ " \$5.95 	766 3 $\frac{1}{8}$ " (BL) \$3.65 	834 3 $\frac{5}{8}$ " \$4.95 	895 3 $\frac{1}{8}$ " \$5.35 	186 4 $\frac{1}{8}$ " (HW) \$3.65 	
233 3 $\frac{5}{8}$ " \$3.95 	774 3" \$3.35 	834Y 3 $\frac{5}{8}$ " \$4.95 	896K 3 $\frac{5}{8}$ " \$5.35 	195 3 $\frac{7}{8}$ " (IP) \$3.35 	
234K 3 $\frac{5}{8}$ " \$3.95 	778 2 $\frac{7}{8}$ " (SS) \$3.35 	835Y 3 $\frac{5}{8}$ " \$4.95 	899 3 $\frac{5}{8}$ " \$5.35 	196 3 $\frac{7}{8}$ " (IP) \$3.35 	
236 3 $\frac{5}{8}$ " \$3.95 	787 4" \$4.35 	861 4" \$5.95 	974 3" \$5.35 	716 3 $\frac{5}{8}$ " (IP) \$3.95 	
272 2 $\frac{7}{8}$ " \$3.65 	793 2 $\frac{7}{8}$ " (MP) \$3.65 	876 2 $\frac{7}{8}$ " (MP) \$6.65 	<b>STAINLESS SAMPLER KNIVES</b>		
293 3 $\frac{7}{8}$ " \$4.65 	804 3 $\frac{7}{8}$ " \$5.95 	879 4" \$5.35 	SS 105 5 $\frac{3}{4}$ " \$5.35 	SS 700 4 $\frac{1}{2}$ " \$5.35 	SS 102 4 $\frac{1}{8}$ " \$3.35 



KEY FOR KNIFE HANDLES



BL.....BLACK PLASTIC  
 K.....K-HORN  
 SS.....STAINLESS STEEL

HW.....HARDWOOD  
 L.....LEATHER  
 WW.....WONDAWOOD

IP.....IVORY PLASTIC  
 MP.....MARINE PEARL  
 Y.....YELLOW

<p>H-15 9 3/4" \$3.35</p> 	<p><b>HAND CRAFTED HUNTING KNIVES</b>                  Each with genuine tooled leather sheath.                  Assorted handles as indicated</p>		<p>147-L 8 3/4" \$3.95</p> 
<p>137-L 8 7/8" \$3.95</p> 	<p>141-L 8 1/2" \$3.95</p> 	<p>144-L 9 3/4" \$4.65</p> 	<p>148-S 9 1/4" \$4.65</p> 
<p>138-L 9 3/8" \$4.65</p> 	<p>142-L 6 3/4" \$3.95</p> 	<p>147-S 8 3/4" \$3.95</p> 	<p>148-L 9 1/4" \$4.65</p> 

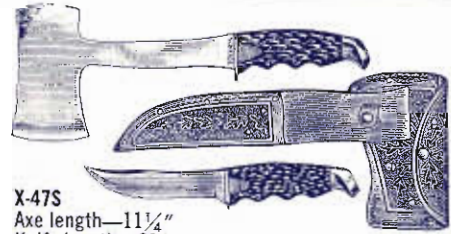
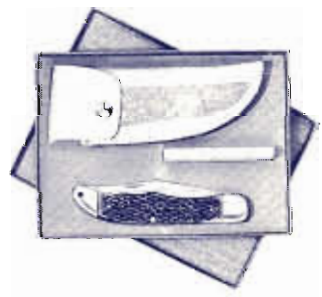

**Combination SAFARI SETS**

 <p>8138 OT (incl. 80T &amp; 138) \$10.95</p>	 <p>X-47S Axe length—11 1/4" Knife length—8 3/4" \$11.95 (gift boxed)</p>  <p>3225 5 1/4" \$7.95</p>	 <p>8147-S (incl. 881 &amp; 147S) \$9.95</p> <p>8148-S (incl. 881 &amp; 148S) \$10.95</p>
--	---	---

**Original OLDTIMER® Knives**

<p>340T 3 3/8" \$5.95</p> 	<p>featuring                  Unique OLD TIMER shields, Bone                  Meerschaum handles and Deluxe                  Individual Gift Boxes</p>	<p>80T 4" \$5.95</p> 
<p>1080T 2 3/4" \$5.35</p> 	<p>250T 5 1/2" \$11.95</p> 	<p>150T 10 1/2" overall \$14.95</p> 

**"RAZOR BLADE STAINLESS"™ KNIVES**

<p>825 RB 3 3/8" \$7.95</p> 	<p>855 RB 3 1/4" \$5.95</p> 
---	---

**GUARANTEE**  
 Every Schrade-Walden knife is guaranteed against defects in workmanship and/or materials for life.

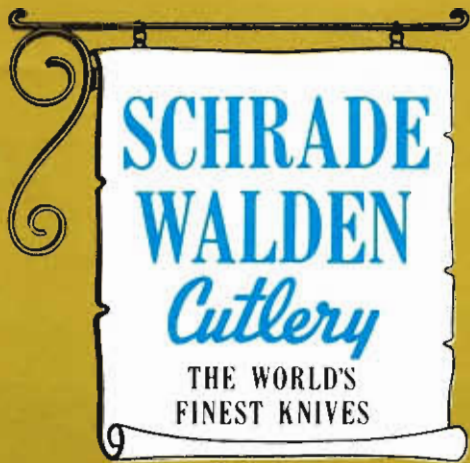

REALLY UNIQUE BUSINESS  
GIFTS FOR ANY MAN

EXCLUSIVE  
**OLD-TIMERS<sup>®</sup>**  
KNIVES



**340T — MIDDLEMAN**  
3-5/16" long closed



**1080T — JUNIOR**  
2 3/4" long closed



**80T — SENIOR**  
4" long closed



**250T — FOLDING HUNTER**  
with sharpening stone and  
leather sheath.  
5 1/4" long closed



**150T — HUNTER**  
with sharpening stone and  
sheath.  
10 1/2" long overall

**A KNIFE LIKE GRANDAD'S . . .**

Here are knives with all the old-fashioned qualities of superior workmanship, good looks and high utility value, and with more sheer cuttin' ability than any other knives in many, many years.

Handmade, hand-honed and hand edged, the blades are crafted of fine hardened and tempered cutlery steel. Each features a Meer-schaum bone handle, exclusive Old Timer shield and is impressively gift boxed in true "he-man" fashion.

**NOTE: The hardness and resiliency of Old Timer handles make it impractical to imprint or stamp.**

Prices shown below are for UNIMPRINTED KNIVES

NUMBER	12-24	25-49	50-99	100 & OVER
1080T	4.50	4.38	4.23	4.00
340T	4.95	4.85	4.62	4.50
80T	4.95	4.85	4.62	4.50
250T	9.80	9.50	9.24	9.00
150T	14.50	13.50	12.20	11.20





# MODERN PILFER-PROOF DISPLAY CASES

FEATURING

- Removable display panels with "KLIPON" holders
- Ample storage space for stock
- Price/number stickers for all patterns
- Packed in individual cartons.

## THREE DESIGNS TO CHOOSE FROM

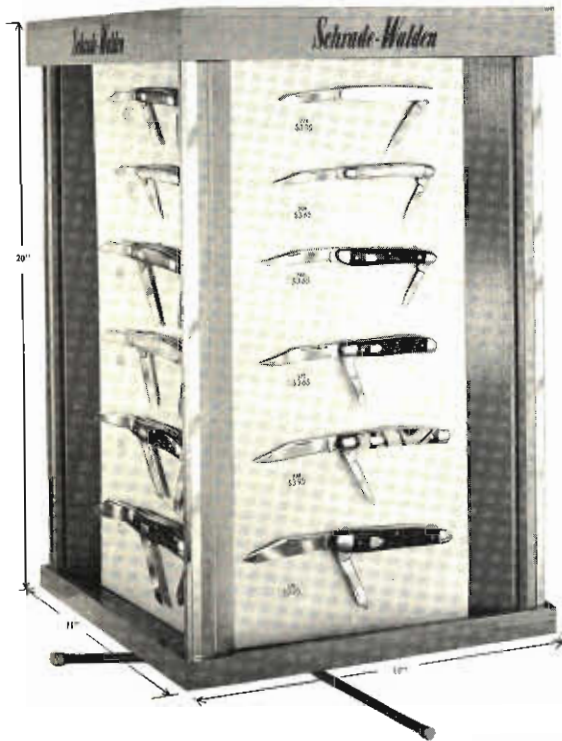

**SW 62**  
**24 PATTERN REVOLVING DISPLAY**  
Weight — approx. 12 lbs.



**SW 61**  
**6 PATTERN COUNTER DISPLAY**  
Weight — approx. 2½ lbs.

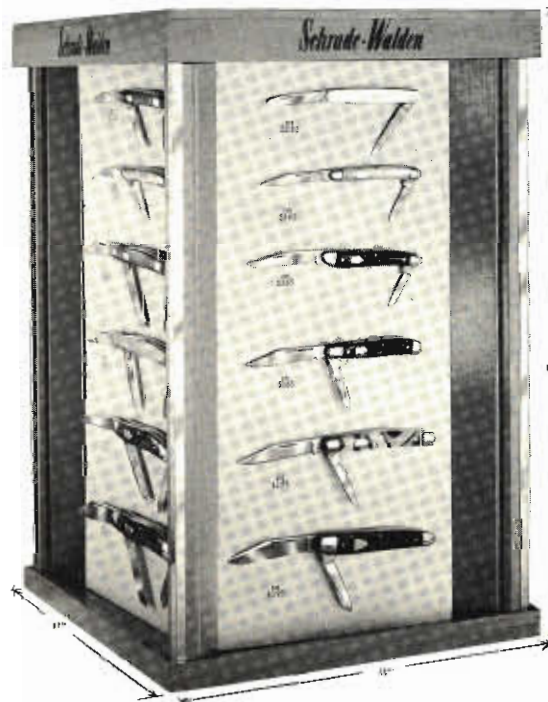

**SW 63**  
**12 PATTERN COUNTER DISPLAY**  
Weight — approx. 8 lbs.

**SCHRADE  
WALDEN**  
Cutlery  
THE WORLD'S  
FINEST KNIVES

# THE BEST PROFESSIONAL QUALITY SCHRADE WALDEN SAMPLERS

These knives are hand made to meet the strictest specifications. Every blade is made of High-Carbon Stainless Steel, heat treated and tempered to insure its edge holding quality. The hand fine glazed finish and hand honing and edging insures its keen cutting quality for those who want the "WORLD'S FINEST SAMPLER KNIVES."

## NOW... THE ONLY SAMPLERS WITH THE REVOLUTIONARY NEW RAZOR BLADE STAINLESS<sup>TM</sup> BLADES

Cut Keener! Last Longer!

### SS700 CITRUS SAMPLER

4½" long RAZOR BLADE STAINLESS SAMPLER  
Unbreakable Marine Pearl handle. Brass linings,  
Nickel Silver bolsters. Maximum imprint — 33  
letters per line, 2 lines per side.



25-49	50-99	100-249	250-499	500-999	1000 & OVER
4.50	4.40	4.30	4.20	4.15	4.10

### SS102 INSPECTOR'S SAMPLER

4-11/16" long RAZOR BLADE STAINLESS SAMPLER  
Unbreakable grained Ivory plastic handle. Brass linings.  
Maximum imprint — 40 letters per line, 2 lines per  
side.



25-49	50-99	100-249	250-499	500-999	1000 & OVER
3.00	2.90	2.84	2.70	2.66	2.60

### SS105 PROFESSIONAL SAMPLER

5¾" long RAZOR BLADE STAINLESS SAMPLER  
Unbreakable grained Ivory plastic handle. Brass  
linings. Maximum imprint—52 letters per line,  
2 lines per side.



25-49	50-99	100-249	250-499	500-999	1000 & OVER
4.50	4.40	4.30	4.20	4.15	4.10

Illustrations are full size.



**778  
PETITE**



Handsome and slim Stainless Steel Vest Pocket knife. Includes one keen Stainless cutting Blade and a flexible Nail File, with satin-finished Stainless cover. 2 7/8", closed.

\*Maximum number of lines: 1-27 letters or spaces per line.

50-99	100-249	250-499	500-999	1000 & OVER
2.90	2.84	2.70	2.66	2.60

**882  
RANCHER**



**RANCHER** Full size Premium Stock for the biggest man on the ranch or farm. 3 husky Blades. Canary yellow unbreakable handle is shielded one side but the other is open for your message. 4", closed.

\*Maximum number of lines: 2-30 letters or spaces per line.

24-49	50-99	100-249	250-499	500-999	1000 & over
4.50	4.40	4.34	4.20	4.16	4.10

**29  
HANDYMAN**



**ULSTER** Brand Utility Knife. Excellent commercial quality with a screwdriver-wirescraper blade that locks when open, and one fine cutting blade. Full mirror polished. Plastic Mahogany handle. Knife, 3 3/4" long when closed.

Maximum number of lines: 2—not over 23 letters or space. per line.

25-49	50-99	100-249	250-499	500-999	1000 & OVER
2.50	2.40	2.34	2.20	2.16	2.10

**176  
FLORIST**

JAY-AR ADV. SPECIALTY

**Florist** knife with one extra-sturdy Grafting Blade. Razor sharp, perfectly balanced for amateur or professional. 3 3/4" closed.

\*Maximum number of lines: 2—not over 23 letters or spaces per line.

25-49	50-99	100-249	250-499	500-999	1000 & OVER
2.50	2.40	2.34	2.20	2.16	2.10

**INDIVIDUAL GIFT BOXES**—16¢ each for samplers. 12¢ each for individual leatherette boxes #103.

**MAILING BOX**—14¢ each. **JINGLE CARD WITH GOOD LUCK PIECE**—5¢ each.

**PERSONALIZED** initials or individual names available at \$1.00 per knife above "unstamped" price.

Quantities from 12-25 pieces with same stamping or engraving—add a "setup" charge of \$10.00 to prices listed for 25 pieces.

**876  
BANKER**

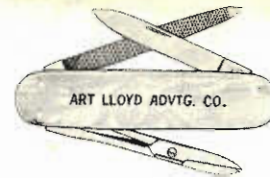

**S12—BANKER** Slim, sturdy. A gentleman's Pocket Knife. Stainless Scissors, flexible Nail File and sharp Stainless Cutting Blade. 2 7/8", closed.

\*Maximum number of imprint lines: 2-25 letters or spaces per line.

25-49	50-99	100-249	250-499	500-999	1000 & OVER
5.50	5.40	5.34	5.20	5.16	5.10

**835Y  
DUDE**



For the rancher who wants a compact Utility Knife that has high quality built into each razor sharp blade. Canary yellow handle is practically unbreakable. One side of the knife has a nickel shield for identification — the other side is ready for your message. 3-5/16", closed.

\*Maximum number of lines: 2-23 letters or spaces per line.

25-49	50-99	100-249	250-499	500-999	1000 & OVER
4.25	4.15	4.09	3.95	3.91	3.85

**163  
ROPE CUTTER**



Big hardwood handle — Heavy Gauge Cutting Blade made of the finest high carbon cutting steel — with hand-glazed, brushed finish—hand honed. Bites through the heaviest hauser with ease. 4 1/2", closed.

Maximum number of lines: 1-39 letters or spaces per line.

25-49	50-99	100-249	250-499	500-999	1000 & OVER
3.25	3.15	3.09	2.95	2.91	2.85

**196  
GARDENER**



**Popular Utility** knife with heavy-duty Pruner Blade and Shackle. Cover of grained ivory plastic. 3 7/8", closed.

\*Maximum number of lines: 2-32 letters or spaces per line.

25-49	50-99	100-249	250-499	500-999	1000 & OVER
3.00	2.90	2.84	2.70	2.66	2.60

**Production time**—approximately four to five weeks. All shipments FOB factory. \*Indicates plastic or ivory handle knives. The lettering can be deep stamped and filled in with a solid color.

\*\*Indicates stainless steel handles that can be deep stamped with a die in large quantities or deep engraved in small quantities.

Both Sides Stamped	25-49	50-99	100-249	250-499	500-999	1000 & over
Add per knife	.30	.22	.14	.10	.08	.06



**SCHRADE  
WALDEN**  
*Cutlery*  
THE WORLD'S  
FINEST KNIVES

HAND-MADE IN THE U.S.A.

**176  
FLORIST**



**FLORIST** Florist knife with one extra-sturdy Grafting Blade. Razor sharp and perfectly balanced for amateur or professional. 3 3/4" closed.

\*Maximum number of lines: 2-not over 23 letters or spaces per line.

25-49	50-99	100-249	250-499	500-999	1000 & over
2.50	2.40	2.34	2.20	2.16	2.10

**196  
GARDENER**



**GARDENER** Popular Utility knife with heavy-duty Pruner Blade and Shackle. Cover of grained ivory plastic. 3 7/8" closed.

\*Maximum number of lines: 2-32 letters or spaces per line.

25-49	50-99	100-249	250-499	500-999	1000 & over
2.76	2.66	2.60	2.46	2.42	2.36

**580T  
OLD TIMER**

84 years of Knife "know-how" built into this Ulster 3 blade Old Timer Pocket Knife. Three fine cutting blades; turkish clip, spey and pen. All blades full mirror polished. Solid brass linings and Old Timer shield. The handle can be engraved with a one line name in quarter-inch high letters at \$1.00 per side. Price of \$3.50 each includes a wood grained gift box and a descriptive folder.



Knife Illustrations 1/2 size.

The world's finest knives made by one of America's leading cutlery firms — distinctively styled and unconditionally guaranteed to give superior performance and keep your company name or slogan in good standing and constant view before your customer.

**163  
ROPE  
CUTTER**



**ROPE CUTTER** Big hardwood handle — Heavy Gauge Cutting Blade made of the finest high carbon cutting steel — with hand-glazed, brushed finish — hand-honed. Bites through the heaviest hauser with ease. 4 1/2" closed.

Maximum number of lines: 1-39 letters or spaces per line.

25-49	50-99	100-249	250-499	500-999	1000 & over
3.25	3.15	3.09	2.95	2.91	2.85

**716  
BOTANIST**



**BOTANIST** Sharp Budding Blade and keen Grafting Blade perfectly heat-treated and tempered — a professional tool — the pride of any gardener. 3 5/8" closed.

\*Maximum number of lines: 2-28 letters or spaces per line.

25-49	50-99	100-249	250-499	500-999	1000 & over
3.50	3.40	3.34	3.20	3.16	3.10

**80T  
OLD TIMER**



The Schrade Walden Old Timer, a knife like Grandad had . . . with more cuttin' strength than any other knife made in many, many years.

Hand-made, hand-honed and edged blades are hardened and tempered. Meerschaum bone type handle is guaranteed against breakage for the "Life of the Knife". The handle can be engraved with an individual's name or firm's name in one-quarter inch high letters, one line only \$1.00 per side per knife. Price of \$5.00 each includes the platform gift box with folder describing the quality of this hand-made product.



# 778 PETITE



*Pouch  
+ .025  
IMPRINT  
+ .05*

**PETITE** Handsome and slim Stainless Steel Vest Pocket knife. Includes one keen Stainless cutting Blade and a flexible Nail File, with polished Stainless cover. 2 7/8", closed.

*\*\*Maximum number of lines: 1-27 letters or spaces per line.*

25-49	50-99	100-249	250-499	500-999	1000 & over
3.00	2.90	2.84	2.70	2.66	2.60

# 835Y DUDE



**DUDE** For the rancher who wants a compact Utility Knife that has high quality built into each razor sharp Blade. Canary yellow handle is practically unbreakable. One side of the knife has a nickel shield for identification—the other side is ready for your message. 3 5/8", closed.

*\*\*Maximum number of lines: 2-23 letters or spaces per line.*

25-49	50-99	100-249	250-499	500-999	1000 & over
4.25	4.15	4.09	3.95	3.91	3.85

# 204SHA HANDYMAN

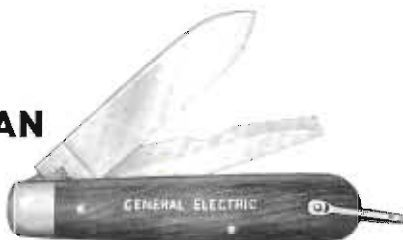

For the Professional Handyman. It is sturdy, strong and solidly made to take rough treatment — Screwdriver Blade that locks when opened and has a Wire Scraper and Peeler and a keen cutting Blade of extra heavy steel. Hardwood handle. 3 3/4", closed.

*Maximum number of lines: 1-23 letters or spaces per line.*

25-49	50-99	100-249	250-499	500-999	1000 & over
3.75	3.65	3.59	3.45	3.41	3.35

# 29 UTILITY



Utility Knife for the Do-It-Yourselfer. Excellent commercial quality with a screwdriver-wirescraper blade that locks when open, and one fine cutting blade. Full mirror polished. Plastic Mahogany handle. Knife, 3 3/4" long when closed. Maximum number of lines: 2 — not over 23 letters or spaces per line.

25-49	50-99	100-249	250-499	500-999	1000 & over
2.50	2.40	2.34	2.20	2.16	2.10

# 882 RANCHER



**RANCHER** Full size Premium Stock for the biggest man on the ranch or farm. 3 husky Blades. Canary yellow unbreakable handle is shielded one side but the other is open for your message. 4", closed.

*\*\*Maximum number of lines: 2-30 letters or spaces per line.*

25-49	50-99	100-249	250-499	500-999	1000 & over
4.50	4.40	4.34	4.20	4.16	4.10

# 916 ARMY OFFICER'S KNIFE



Five rustproof stainless tools and shackle at your fingertips. New type Army Canopener (cuts down). Red, unbreakable plastic handle. 3 3/4" closed.

*Maximum number of lines: 2 - 30 letters or spaces per line.*

25-49	50-99	100-249	250-499	500-999	1000 & over
4.00	3.90	3.84	3.70	3.66	3.60

# 876 BANKER



**S12-BANKER** Slim, sturdy. A gentleman's Pocket Knife with Stainless Scissors, flexible Nail File and sharp Stainless Cutting Blade. 2 7/8", closed.

*\*\*Maximum number of imprint lines: 2-25 letters or spaces per line.*

25-49	50-99	100-249	250-499	500-999	1000 & over
5.50	5.40	5.34	5.20	5.16	5.10

**MAXIMUM** number of lines and characters or spaces shown under each knife. Interchangeable block type.

Plain knives not stamped deduct 10¢ per knife from list price. Special types of trademarks — quotations given on review of samples.

**INDIVIDUAL GIFT BOXES**—16¢ each for samplers. 12¢ each for individual leatherette boxes #103.

**MAILING BOX** (to fit individual Gift Boxes)—14¢ each.

**JINGLE CARD WITH GOOD LUCK PIECE** — 5¢ each.

**PERSONALIZED** initials or individual names available at \$1.00 per knife above "unstamped" price.

A typed duplicate list on a separate sheet will insure your identification of each knife. Factory will use your second list, wrapping each name on the outside of the individual's knife.

Quantities from 12-25 pieces with same stamping or engraving — add a "setup" charge of \$5.00 to prices listed for 25 pieces.

**Production time** — approximately four to five weeks.

**DROP SHIPMENTS** must be accompanied by shipping labels. —

All shipments F.O.B. Factory

*\*Indicates plastic or ivory handle knives. The lettering can be deep stamped and filled in with a solid color.*

*\*\*Indicates stainless steel handles that can be deep stamped with a die in large quantities or deep engraved in small quantities*

Both Sides Stamped	25-49	50-99	100-249	250-499	500-999	1000 & over
Add per Knife	.30	.22	.14	.10	.08	.06



**SCHRADE  
WALDEN**  
*Cutlery*  
THE WORLD'S  
FINEST KNIVES

# THE BEST PROFESSIONAL QUALITY SCHRADE WALDEN SAMPLERS

MADE IN THE U.S.A.

These knives are hand made to meet the strictest specifications. Every blade is made of High Carbon Stainless Steel, heat treated and tempered to insure its edge holding quality. The hand fine glazed finish, and hand-honing and edging, insures its keen cutting quality, for quality, for those who want the "WORLD'S FINEST SAMPLER KNIVES."

## SS700 CITRUS SAMPLER

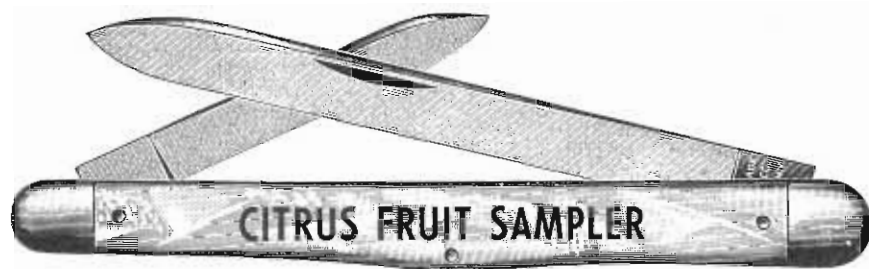

4½" long Sampler with 2 Stainless Steel Blades, fine glazed hand honed and edged. Marine unbreakable Pearl plastic handle. Brass linings, nickel silver bolsters. Maximum imprinting is 33 letters per line — 2 lines per side.

SS700WE — Same as above, but with Patented Wonda-Edge blade.

25-49	50-99	100-249	250-499	500-999	1000 & over
4.50	4.40	4.30	4.20	4.15	4.10

## SS102 INSPECTOR'S SAMPLER



4-11/16" Stainless Steel Blade fine glazed hand honed edged. Unbreakable grained ivory plastic handle. Brass linings. Maximum imprinting is 40 letters per line — 2 lines per side.

SS102WE — Same as above, but with Patented Wonda-Edge blade.

25-49	50-99	100-249	250-499	500-999	1000 & over
3.00	2.90	2.84	2.70	2.66	2.60

Illustrations are full size.

PAGE



**SCHRADE  
WALDEN**  
Cutlery  
THE WORLD'S  
FINEST KNIVES

# THE BEST PROFESSIONAL QUALITY SCHRADE WALDEN SAMPLER

MADE IN THE U.S.A.

These knives are hand made to meet the strictest specifications. Every blade is made of High Carbon Stainless Steel, heat treated and tempered to insure its edge holding quality. The hand fine glazed finish, and hand-honing and edging, insures its keen cutting quality, for quality, for those who want the "WORLD'S FINEST SAMPLER KNIVES."

## SS105 PROFESSIONAL SAMPLER

NEW  
\*WONDA-EDGE →  
BLADE



5 3/4" Stainless Steel blade fine glazed hand honed and edged. Unbreakable grained ivory plastic handle. Brass linings. Maximum imprinting 52 letters per line — 2 lines per side.

SS105WE ILLUSTRATED — Same as above but with Patented Wonda-Edge blade.

25-49	50-99	100-249	250-499	500-999	1000 & over
4.50	4.40	4.30	4.20	4.15	4.10



# ULSTER QUALITY COMMERCIAL SAMPLER

## US-5 COMMERCIAL SAMPLER



For the Competitive Market — combining economy of price with satisfaction in service. 5 3/4" high carbon Stainless Steel blade hand edged and mirror polished. White "IVOROID" plastic handles are durable, clean and sanitary. Solid brass linings. Maximum imprinting 40 letters per line — 2 lines per side.

US-5WE — Same as above, but with Patented Wonda-Edge blade.

	25-49	50-99	100-249	250-499	500-999	1000 & over
US-5	2.00	1.90	1.80	1.70	1.65	1.60
US-5 WE	2.25	2.15	2.05	1.95	1.90	1.85

Illustrations are full size

MADE IN U.S.A. PRINTED IN U.S.A.



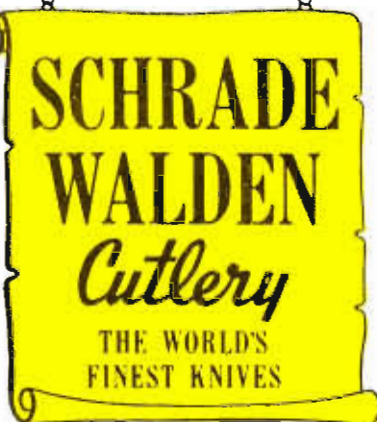

# ORIGINAL OLD-TIMERS®

KNIVES LIKE GRANDAD HAD

- Hand-made, hand-honed and hand-edged.
- Unique Meerschaum Bone Handles with distinctive OLD TIMER shields.
- Individual Custom Gift Packaging.

SCHRADER-WALDEN CUTLERY CORP.  
DIV. OF IMPERIAL KNIFE ASSOC. COS., INC.



**No. 340T**  
3 7/8" Serpentine Bladed Clip, Sheepfoot and Pen Handle—Meerschaum Unbreakable Plastic with "Old Timer" shield.  
Weight per Dozen, 1 lb., 4 oz.



**No. 1080T**  
2 3/4" Full Premium Stock Bladed Clip, Sheepfoot and Pen Handle—Meerschaum Unbreakable Plastic with "Old Timer" shield.  
Weight per Dozen, 2 lbs., 4 oz.



**No. 150T**  
5 1/4" Hunter's & Trapper's Bladed Large Saber Clip & Large Skinning Handle—Meerschaum Unbreakable Plastic with "Old Timer" shield.  
With Genuine Leather Sheath and sharpening stone in 2 pc. Woodgrained Gift Box  
Weight approx. 8 lbs. per dozen.



**No. 80T**  
4" Full Premium Stock Bladed Clip, Sheepfoot & Spey Handle—Meerschaum Unbreakable Plastic with "Old Timer" shield.  
Weight per Dozen, 2 lbs., 6 oz.



**No. 250T**  
5 1/4" Hunter's & Trapper's Bladed Large Saber Clip & Large Skinning Handle—Meerschaum Unbreakable Plastic with "Old Timer" shield.  
Weight per Dozen, 4 lbs., 12 oz.



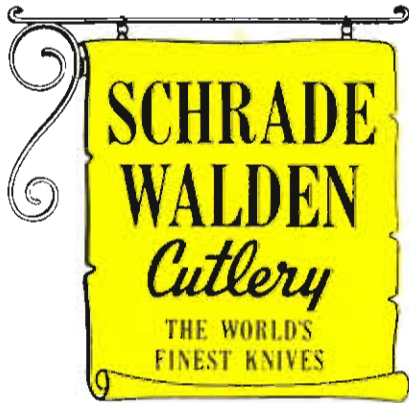

**Revolutionary New**  
**RAZOR BLADE STAINLESS™**  
**Pocket Knives.**

Cut Cleaner & Last Longer — Just Like Stainless Razor Blades!



**HANDSOME  
 NEW DISPLAY**

Holds 3 only 825 RB's  
 Each in plastic gift box

**No. 825 RB**  
 "Razor Blade" Stainless"  
 Slim Premium Stock  
 3 7/8" long  
 Turkish Clip, Sheepfoot and Spey blades.  
 Unbreakable Staglon® Handle  
 Weight per asst. (3 knives) 1 lb., 4 oz.

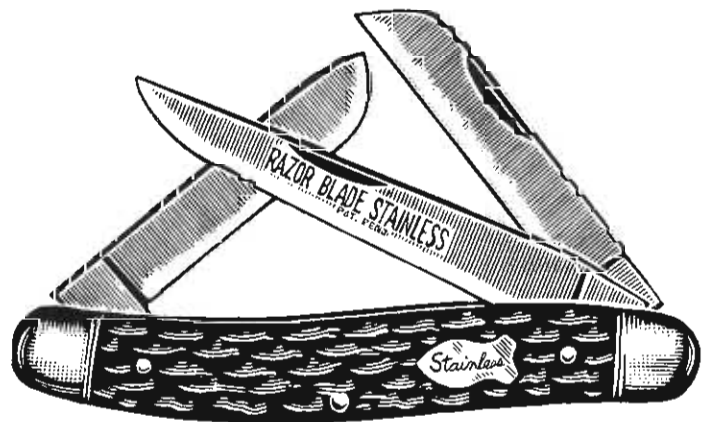

(Illustrated actual size)





# Revolutionary New RAZOR BLADE STAINLESS™ Pocket Knife

**Cuts Cleaner & Lasts Longer —  
Just Like A Stainless Razor Blade**



(Illustrated actual size)

**825RB**

This amazing new product cuts like no other pocket knife ever — even a “regular” Schrade Walden!

Features include a unique “STAINLESS” color-stamped shield and special blade etch.



**NOTE:**

The non-breakable STAGLON® stag handle on this knife CANNOT be hot stamped or imprinted. Prices shown below are for UNIMPRINTED KNIVES.

12-24	25-49	50-99	100 & OVER
6.80	6.50	6.24	6.00



Handsome Gift Box Included  
Free with each knife  
COVER CAN BE IMPRINTED  
AT 10¢ ADDITIONAL PER BOX





HAND MADE IN U.S.A.

DP-8 1.85 ea. DP-58 1.85 (580T in 340T box)  
 See special price list for Gamble Skogmo stores  
 Liberty Distributors - 148S - 1.575-  
 S & H 208 - 1.56 - SW4114 (914) 1.50 - 147S - 1.50  
 1964 SNOBOY 88700 - 2.15 each  
 Shedd Brown - 80T 2.25 ea. imprinting .50 ea.

*Norm  
Shompson  
see sheet*

**DISTRIBUTOR'S COST**

PRICE LIST SW164-J  
 (Effective 1/1/64)

Knox Wollen - #752 - 18.00 doz.

King Korn U208 - 1.93 less 5%

Chain Store prices - Short Line less 50 - 10.

*Liberty wholesalers  
580T - Boxed 22.50  
21.00*

*340TS  
24.00*

Number	Price Pr.Dz.	Number	Price Pr.Dz.	Number	Price Pr.Dz.	Number	Price Pr.Dz.
*340T	27.00	236	18.00	793	16.50	*876	30.00
*80T	27.00	272	16.50	804	27.00	879	24.00
*1080T	24.00	293	21.00	805	24.00	880	24.00
115	10.50	293Y	21.00	808	21.00	881	24.00
136	16.50	294	21.00	808Y	21.00	881Y	24.00
163	16.50	708	16.50	825	27.00	882Y	24.00
204SHA	19.50	708Y	16.50	825RB	36.00	883	24.00
218	16.50	735	30.00	832	22.50	895	24.00
219	16.50	766	16.50	834	22.50	896K	24.00
225	27.00	774	15.00	834Y	22.50	899	24.00
233	18.00	778	15.00	835Y	22.50	974	24.00
234K	18.00	787	19.50	861	27.00	<del>876RB 27.00</del>	
<del>250T 54.00</del>		<del>855RB 27.00</del>		<del>776RB 21.00</del>		914	24.00
250T	3.35 ea	225TC	36.00	<del>708RB 24.00</del>		718TCB	24.00
No stone or box		<b>HUNTING KNIVES</b>				<b>SAFARI SETS</b>	
H15	15.00	142L	18.00	148L	21.00	*8138-OT	54.00
137L	18.00	144L	21.00	148S	21.00	*8147-S	48.00
138L	21.00	147L	<del>18.00</del> 21.00	X47	54.00	*8148-S	51.00
141L	18.00	147S	18.00	SW19	19.50/	*3225	36.00
150T	67.20	22		SW20	Asst. 18.00		
		1465TC	36.00	SWOTD Ass't 33.20 ea.		<b>DISPLAY CASES FREE WITH BULK PACKED KNIVES</b>	
		148LTC	36.00			SW61 w/3 doz.	
<b>HORTICULTURAL</b>				<b>SAMPLERS</b>		SW63 w/6 doz.	
173	7.20	186	16.50	SS102	15.00	SW62 w/9 doz.	
174	7.20	195	15.00	SS105RB	24.00	*SW191 w/1 doz.	
175	12.00	196	15.00	SS700	24.00	*Hunting knives, except H15 & 142.	
176	12.00	716	18.00	FC1 - 255.45			
182	13.50			FC2 - 281.30			
				FC4 - 278.70			
		250TB	36.00				

\*Individually boxed *Knives sharpened*

Maher & Gosh - etching 6 to 11 doz. of one pattern 1.20 per doz.  
 12 doz and over .60 " "

Blake - Wall Rope 1.525 ea. both sides imprinted, on releases of less than 25 change 2.50 for set up. *1.425 1 side*  
 All Prices Are Subject to Change Without Notice

Bazaar - 735L - 25.00 doz.

Masback - 147L - 1.35 ea.

Borden's SS105 - 2.25 ea.

Crestfield 580T - 15.00 TERMS: 1% 10, net 30 days

1080T - 21.00 FOB: Ellenville, N. Y.

Brown and Williamson  
 580T - 1.66  
 208 - 1.75

Moore Handley Drop Shp  
 50-10-5 off short line prices.

*2 Corp 778RB - 18.00  
 Eaton 878RB - 24.00  
 Less 15%*

For drop shipment add 10%

MINIMUM ORDER - 1 DOZ. of a PATTERN

SCHRADE WALDEN CUTLERY CORP. - 1776 Broadway, New York 19, N.Y.